

FM IF IC FOR PAGERS

■ GENERAL DESCRIPTION

The **NJM2537** is a low power FM IF IC for pagers.

It is capable of designing dual conversion pager system because of including a mixer circuit. Also it includes RSSI function, so that it is easy to design automatic gain control (AGC) which improves interference when strong signal is received.

■ PACKAGE OUTLINE

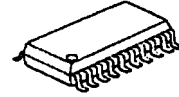

NJM2537V

■ FEATURES

- Low Operating Voltage 1.1 to 4.0V
- Low Operating Current 1.2mA typ.at V⁺=1.4V
- RF Input Frequency 10 to 50MHz
- 2nd Mixer
- Package Outline SSOP20

■ PIN FUNCTION AND BLOCK DIAGRAM

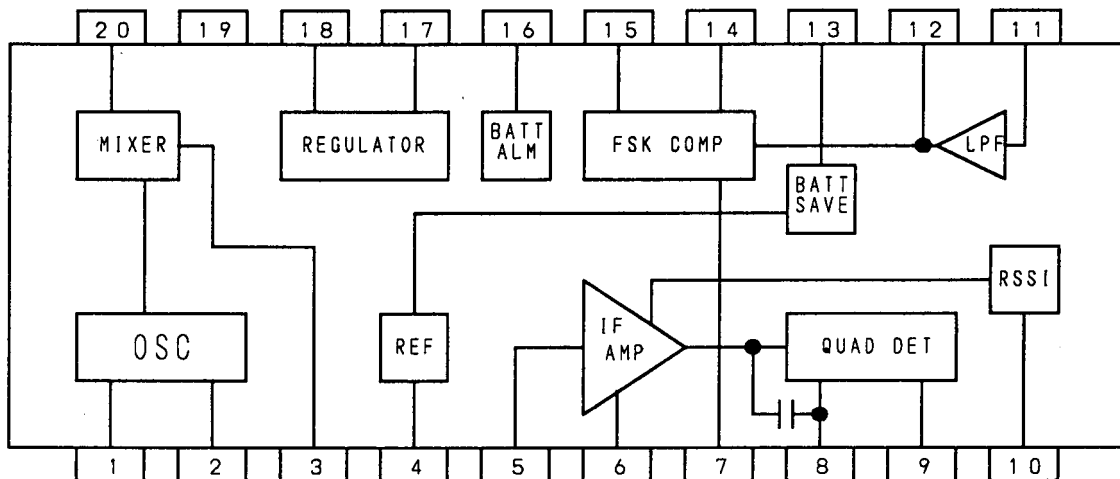

- | | |
|-------------------|--------------|
| 1. OSC IN | 11. LPF IN |
| 2. OSC OUT | 12. LPF OUT |
| 3. MIXER OUT | 13. BS |
| 4. V ⁺ | 14. CHARGE |
| 5. IF IN | 15. FSK OUT |
| 6. DECOUPLING | 16. VALM |
| 7. FSK REF | 17. REG CONT |
| 8. QUAD IN | 18. REG OUT |
| 9. AF OUT | 19. GND |
| 10. RSSI | 20. MIXER IN |

NJM2537

■ ABSOLUTE MAXIMUM RATINGS

($T_a=25^\circ\text{C}$)

PARAMETER	SYMBOL	RATINGS	UNIT
Supply voltage	V_{CC}	4.0	V
Power Dissipation	P_D	300	mW
Operating Temperature Range	T_{opr}	-30 to +85	$^\circ\text{C}$
Storage Temperature Range	T_{stg}	-40 to +125	$^\circ\text{C}$

■ ELECTRICAL CHARACTERISTICS

($V^+=1.4\text{V}$, $f_c=21.7\text{MHz}$, $f_{IF}=455\text{kHz}$, $f_{mod}=600\text{Hz}$, $f_{dev}=\pm 4\text{kHz}$, $T_a=25^\circ\text{C}$)

PARAMETER	SYMBOL	TEST CONDITION	MIN.	TYP.	MAX.	UNIT
No Signal Operating Current	I_{CCq}		-	1.2	1.5	mA
Battery Saving	I_{CCS}		-	0	5	μA
Operating Current Mixer Gain	GMIX	After Ceramic Filter	11	14.5	18	dB
Mixer Intercept Point	IP		-	103	-	$\text{dB}\mu\text{VEMF}$
Mixer Input Resistance	R_{inMIX}		-	5	-	$\text{k}\Omega$
Mixer Output Resistance	R_{oMIX}		-	2	-	$\text{k}\Omega$
IF Amplifier Input Resistance	R_{inIF}		-	2	-	$\text{k}\Omega$
S / N 1	S / N 1	MIXER Input, $V_i=60\text{dB}\mu\text{VEMF}$	-	63	-	dB
S / N 2	S / N 2	IF Input, $V_i=60\text{dB}\mu\text{VEMF}$	-	63	-	dB
S / N 3	S / N 3	IF Input, $V_i=22\text{dB}\mu\text{VEMF}$	-	25	-	dB
-3dB Limiting Sensitivity 1	LIM1	MIXER Input	-	12	17	$\text{dB}\mu\text{VEMF}$
-3dB Limiting Sensitivity 2	LIM2	IF Input	-	22	27	$\text{dB}\mu\text{VEMF}$
Demodulated Output Level	V_{od}	IF Input, $V_i=60\text{dB}\mu\text{VEMF}$	30	46	65	mVrms
AM Rejection Ratio	AMR	IF Input, $V_i=60\text{dB}\mu\text{VEMF}$, AM=30%	-	50	-	dB
Duty Ratio at Wave Shaped Output	DR	IF Input, $V_i=60\text{dB}\mu\text{VEMF}$	40	50	60	%
RSSI Output Voltage	V_{RSSI}	IF Input, $V_i=65\text{dB}\mu\text{VEMF}$	0.48	0.62	0.76	V
RSSI Output Resistance	R_{RSSI}		-	62	-	$\text{k}\Omega$
Quick Charge / Discharge Current	I_{ch}	GND, 0.18V	40	70	115	μA
Alarm Detection Voltage	V_{alm}		1.05	1.10	1.15	V
Regulator Output Voltage	V_{reg}	$R_L=430\Omega$	0.95	1.00	1.05	V
Low level Output Voltage of VALM Terminal	V_{almL}	$I_L=100\mu\text{A}$	-	0.1	0.4	V
High Level Leak Current of VALM Terminal	I_{almH}		-	0	2	μA
Low Level Output Voltage of FSK-OUT Terminal	V_{fskL}	$I_L=100\mu\text{A}$	-	0.1	0.4	V
High Level Leak Current of FSK-OUT Terminal	I_{fskH}		-	0	2	μA
Low Level Output Voltage of REG-OUT Terminal	V_{regL}	$I_L=100\mu\text{A}$	-	-	0.6	V

APPLICATION CIRCUIT

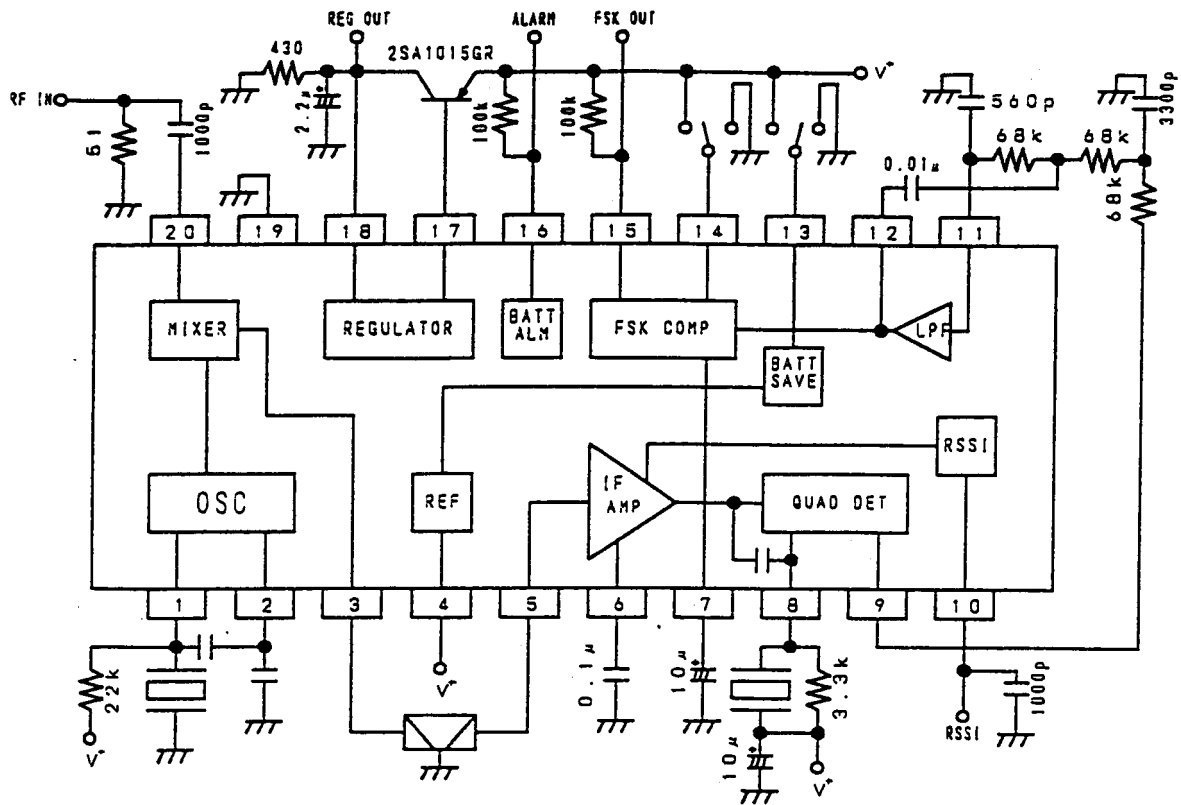

NJM2537

■ TERMINAL FUNCTION

PIN NO.	SYMBOL	PIN VOLTAGE (V)	FUNCTION	EQUIVALENT CIRCUIT
1	OSC IN	1.38	Local Oscillator Input. In case of using a crystal oscillator, it is connected.	
2	OSC OUT	0.68	Local Oscillator Output. In case of using an external oscillator, the external clock is input.	
20	MIX IN	0.8	Mixer input. Input resistance is 5kΩ typical.	
3	MIX OUT	0.7	Mixer output. Output resistance is 2kΩ typical.	
5	IF IN	1.38	Limiter amplifier input. Input resistance is 2kΩ typical.	
6	DEC	1.38	Decoupling for bias.	
8	QUAD IN	1.4	Input of quadrature detection circuit. A ceramic discriminator is connected.	
9	AF OUT	0.16	Demodulated signal Output.	

■ TERMINAL FUNCTION

PIN NO.	SYMBOL	PIN VOLTAGE (V)	FUNCTION	EQUIVALENT CIRCUIT
10	RSSI	0	RSSI output	
11	LPF IN	0.18	Input of a low pass filter. It is biased from AF-OUT (9pin) through an external RC filter.	
12	LPF OUT	0.18	Output of a low pass filter.	
7	FSK REF	0.18	Reference input of a wave shaping comparator. An external capacitor is connected.	
13	BS	-	Control of a battery saving circuit. Hi : active Lo : suspended	
14	CHARGE	-	Control of a quick charge / discharge circuit. Hi : Its circuit turns ON Lo : Its circuit turns OFF	
15	FSK OUT	-	Output of a wave shaping circuit. The output signal is inverted against LPF output signal.	

NJM2537

■ TERMINAL FUNCTION

PIN NO.	SYMBOL	PIN VOLTAGE (V)	FUNCTION	EQUIVALENT CIRCUIT
16	VALM	0.1	Output of the alarm signal. When V^+ drops down to 1.1V, this output becomes high.	
17	REG CONT	0.6	Control of an external PNP transistor used for the regulator.	
18	REG OUT	1.0	Monitoring of the regulator.	
4	V^+	-	Power Supply	-
19	GND	-	Ground	-

■ TYPICAL CHARACTERISTICS

S+N, N, AMR vs. Mixer Input

($V^+ = 1.4V$, $f_{RF} = 21.7MHz$, $f_{LO} = 22.155MHz$
 $V_{LO} = 110dBuV$, $f_{dev} = \pm 4kHz$, $f_{mod} = 600Hz$)

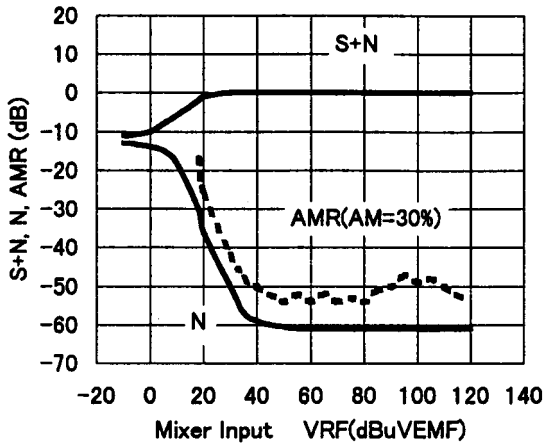

S+N, N, AMR vs. IF Input

($V^+ = 1.4V$, $f_{IF} = 455kHz$, $f_{dev} = \pm 4kHz$, $f_{mod} = 600Hz$)

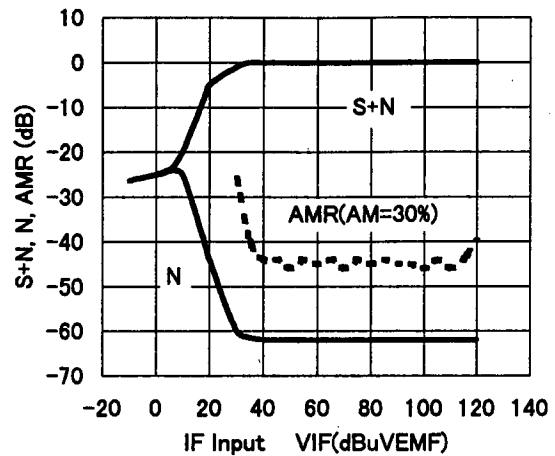

Mixer Gain vs. Supply Voltage

($f_{in} = 21.7MHz$, $V_{RF} = 60dBuV$, $f_{LO} = 22.155MHz$, $V_{LO} = 110dBuV$)

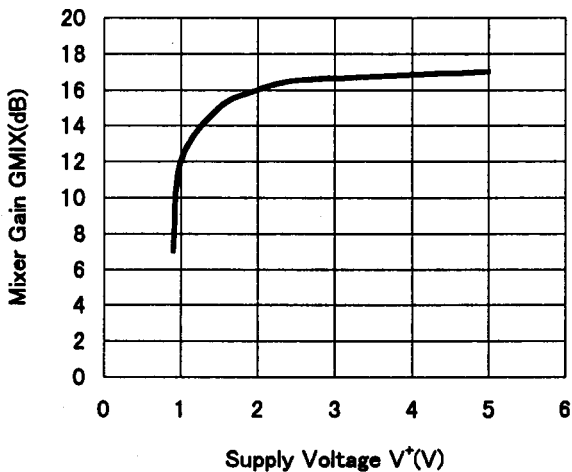

Operating Current vs. Supply Voltage

(No Signal)

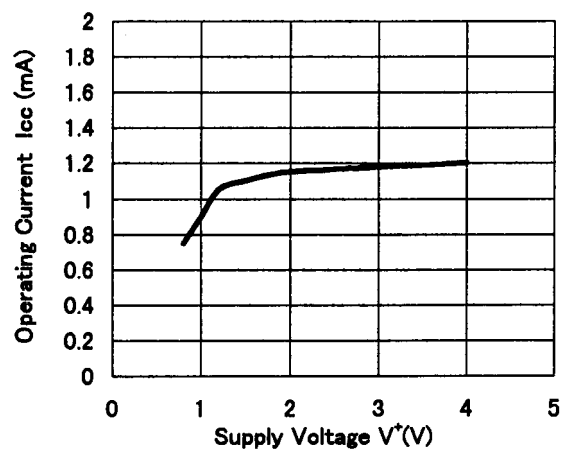

RSSI vs. Supply Voltage

($V_{IF} = 65dBuVEMF$, $f_{IF} = 455kHz$)

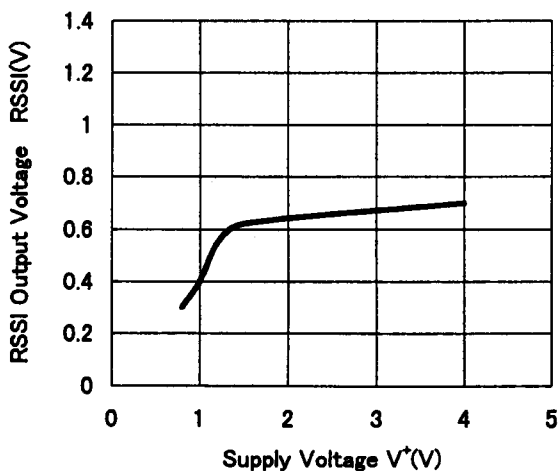

Demodulated Output vs. Supply Voltage

($V_{in} = 60dBuVEMF$, $f_{IF} = 455kHz$, $f_{mod} = 600Hz$)

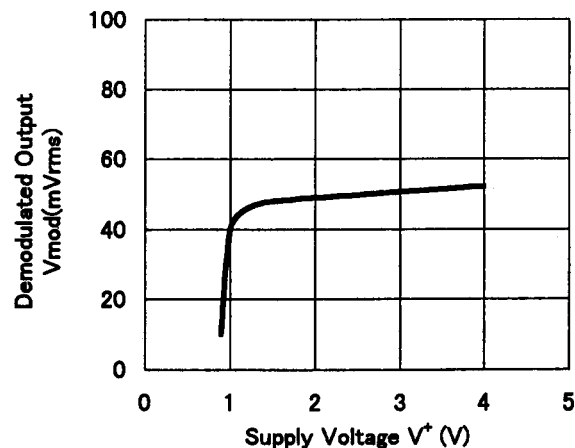

■ TYPICAL CHARACTERISTICS

Quick Charge Current vs. Supply Current
(12pin=0.18V)

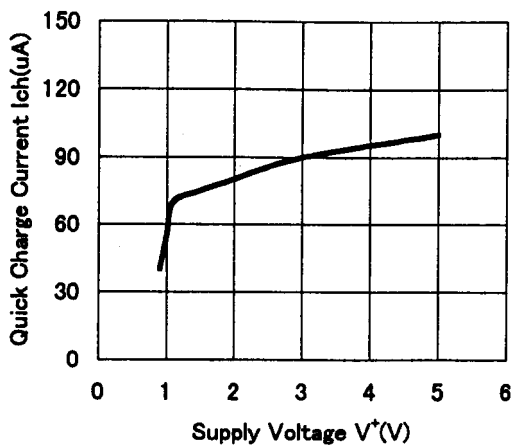

Operating Current vs. Temperature
(V⁺=1.4V)

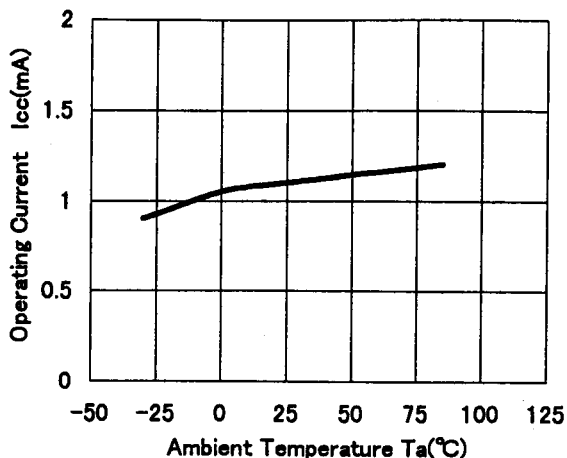

Battery Saving Operating Current vs. Temperature
(V⁺=1.4V)

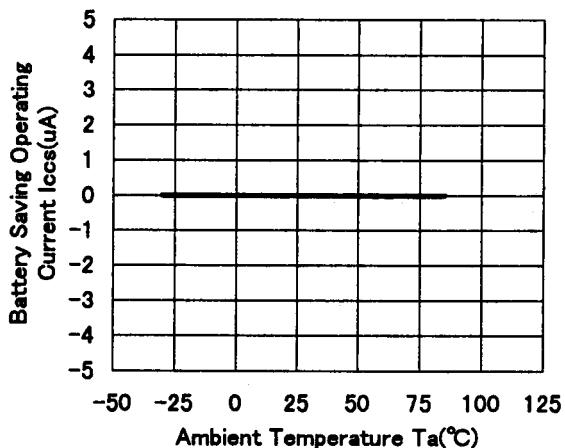

Quick Charge Current vs. Temperature
(V⁺=1.4V, 12pin=0.18V)

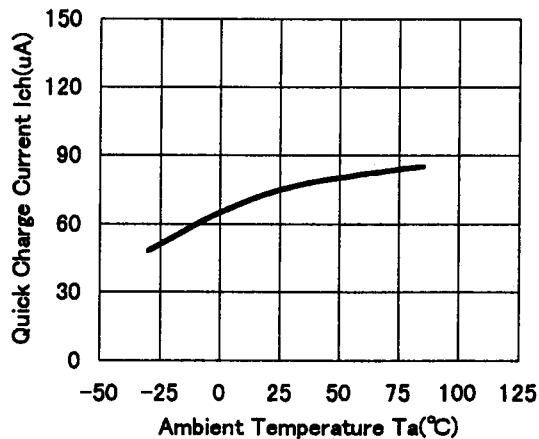

Mixer Gain vs. Temperature
(V⁺=1.4V, f_{RF}=21.7MHz, V_{in}=60dBμV)

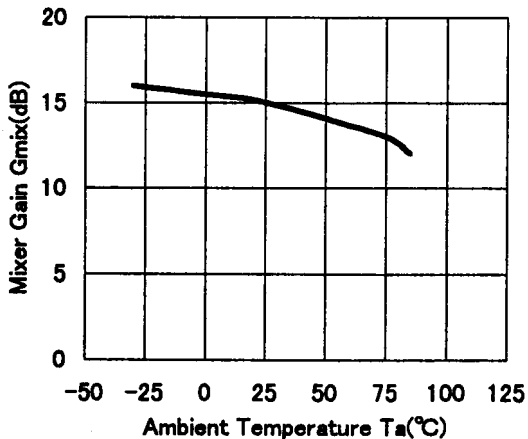

Demodulated Output vs. Temperature
(V⁺=1.4V, f_{IF}=455kHz, V_{in}=60dBμVEMF, f_{mod}=600Hz)

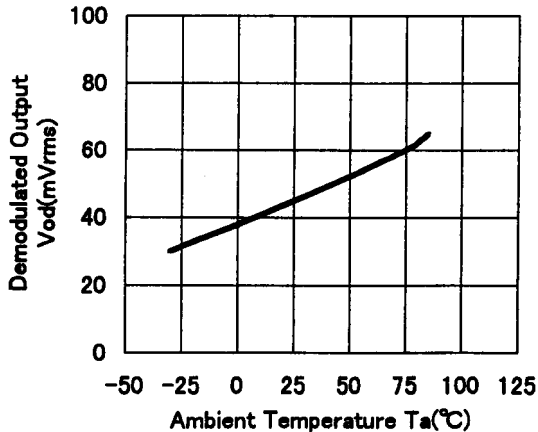

■ TYPICAL CHARACTERISTICS

RSSI vs. Temperature

($V^+ = 1.4V$, $f_{RF} = 21.7MHz$, $V_{RF} = 50dBuVEMF$,
 $f_{LO} = 22.155MHz$, $V_{LO} = 110dBuV$, $mod = OFF$)

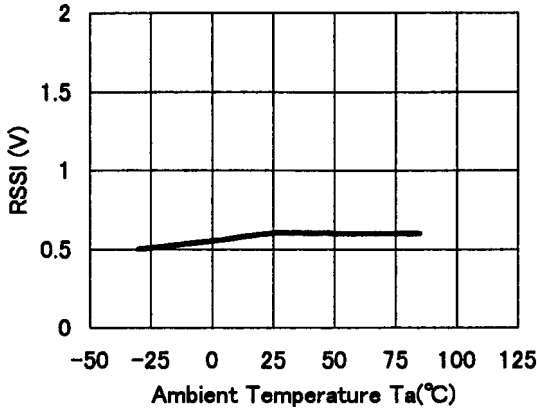

-3dB Limiting Sensitivity vs. Temperature

($V^+ = 1.4V$, Mixer input, $f_{RF} = 21.7MHz$, $f_{mod} = 600Hz$)

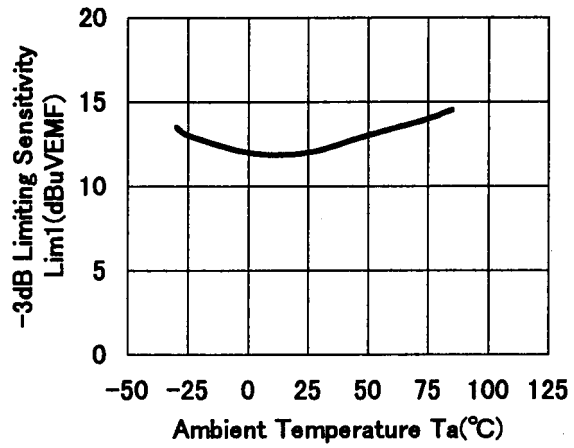

Mixer Output vs. RF Input

($V^+ = 1.4V$, $f_{RF} = 21.7MHz$, $f_{LO} = 22.155MHz$, $V_{LO} = 110dBuV$)

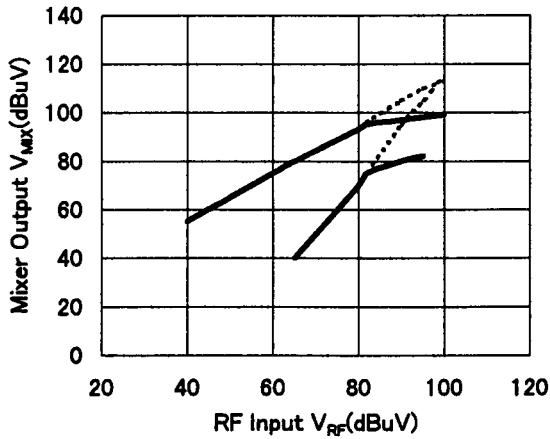

Mixer Gain vs. Local Oscillation

($V^+ = 1.4V$, $f_{RF} = 21.7MHz$, $V_{RF} = 60dBuV$,
 $f_{LO} = 22.155MHz$, $V_{in} = 60dBuV$)

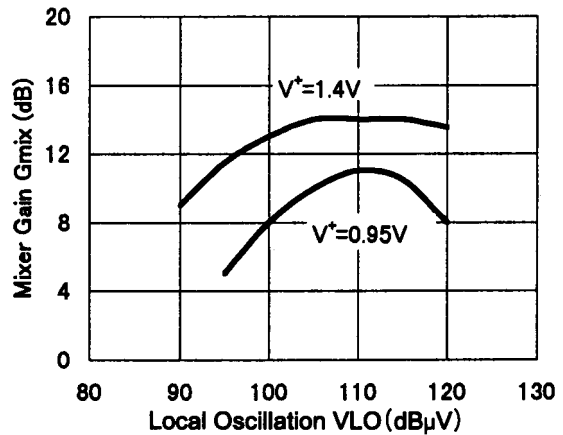

Mixer Gain vs. Frequency

($V^+ = 1.4V$, $V_{RF} = 60dBuV$, $V_{LO} = 110dBuV$, $f_{LO} = f_{RF} + 455kHz$)

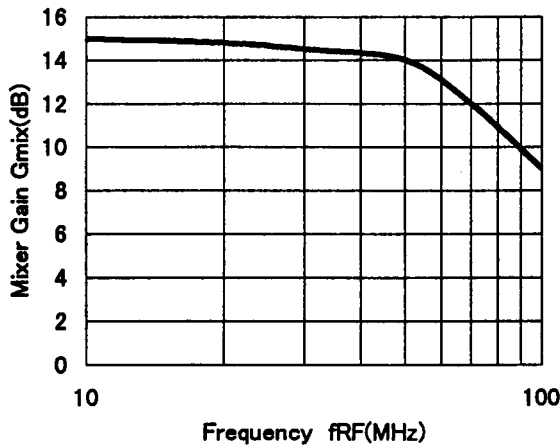

RSSI vs. IF Input

($V^+ = 1.4V$, $f_{IF} = 455kHz$)

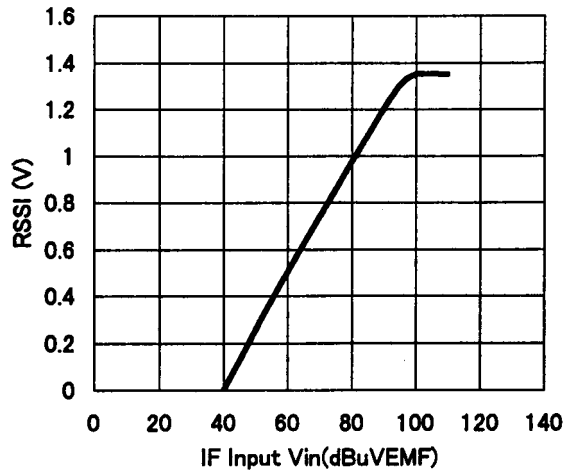

[CAUTION]

The specifications on this databook are only given for information, without any guarantee as regards either mistakes or omissions. The application circuits in this databook are described only to show representative usages of the product and not intended for the guarantee or permission of any right including the industrial rights.